

**STANDARDIZATION MANUAL  
and  
AMPLIFIED PROCEDURES**

**LAKE ELMO**



**AERO**

**PIPER PA-34-200  
SENECA**

Revised May 2022

# Table of Contents

- GENERAL INFORMATION .....3
  - Operating Rules – Multiengine Training.....3
  - Revision History .....3
- QUICK REFERENCE GUIDE.....4
  - V-Speeds .....4
  - Takeoff Performance .....4
  - Cruise Performance .....4
  - Landing Performance .....4
  - Weight and Balance Information .....5
- ACS TASKS – COMMERCIAL MULTIENGINE ADD-ON.....6
- SYSTEMS INFORMATION .....7
  - Engines .....7
  - Fuel System.....7
  - Propeller System.....8
  - Electrical System.....8
  - Landing Gear System .....9
  - External Lights ..... 11
  - Lighting Guide..... 12
- COMMON TASKS ..... 13
  - Traffic Pattern Arrival ..... 13
  - Traffic Pattern Departure ..... 14
  - Traffic Pattern Quick Reference ..... 15
  - Clearing Turns..... 16
  - Configuring the Aircraft for Maneuvers ..... 17
- TAKEOFFS AND LANDINGS ..... 18
  - Normal Takeoff and Climb..... 18
  - Crosswind Takeoff and Climb ..... 19
  - Short Field Takeoff ..... 20
  - Takeoff Briefing ..... 21
  - Normal Approach and Landing ..... 22
  - Crosswind Approach and Landing ..... 23
  - Short Field Approach and Landing ..... 24

Go-Around/Balked Landing ..... 25

PERFORMANCE MANEUVERS ..... 26

    Steep Turns..... 26

    Slow Flight ..... 27

    Power-On Stall ..... 28

    Power-Off Stall ..... 29

    Accelerated Stall..... 30

    Demonstration of VMCA ..... 31

    Demonstration of Drag..... 32

INSTRUMENT FLIGHT ..... 33

    Recovery From Unusual Attitudes..... 33

    Instrument Approach ..... 34

    Holding ..... 35

EMERGENCIES..... 36

    Engine Failure in Flight ..... 36

    Engine Shutdown and Feathering ..... 37

    Engine-Out Instrument Approach ..... 38

    Fuel Crossfeeding ..... 39

    Engine In-Flight Restart ..... 40

    Engine Warm-Up ..... 41

    Engine Failure on Takeoff ..... 42

    Engine Fire in Flight ..... 43

    Engine Fire on Start ..... 44

    Electrical Fire ..... 45

    Emergency Descent ..... 46

    Engine Roughness..... 47

    Emergency Landing Gear Extension ..... 48

    Loss of Oil Pressure..... 49

    High Oil Temperature ..... 50

    Alternator Failure ..... 51

    Electrical System Failure..... 52

    Spin Recovery ..... 53

## GENERAL INFORMATION

This standardization manual is published to serve as a master reference document for expanded aircraft procedures during training. It does not replace the Pilot's Operating Handbook or any other document published by the manufacturer, nor does it replace the Airplane Flying Handbook or any other document published by the FAA.

This manual is intended as a reference for training **at the Commercial certificate level**. Ensure that you are studying, training and performing maneuvers to the applicable standards and procedures.

References to "POH" indicate the aircraft Pilot's Operating Handbook for the 1972 Piper PA-34 Seneca.

References to "AFH" indicate the Airplane Flying Handbook, FAA-H-8083-3B.

References to "IPH" indicate the Instrument Procedures Handbook, FAA-H-8083-16B.

With regards to emergencies, "Land as Soon as Practical" means that a return to the home base airport (21D) is recommended. "Land as Soon as Possible" means a landing at the nearest suitable airport or landing site is recommended, and return to the base airport should not be prioritized.

### Operating Rules – Multiengine Training

On any flight which involves simulated engine shutdowns below 1000' AGL, no rear seat passengers are permitted. In general, rear seat passengers are discouraged during single-engine operation and training due to deteriorated climb performance.

Intentional full shutdown of an engine for training purposes will not commence below 3000' AGL, and only within gliding distance of an airport with major powerplant maintenance available.

Simulated engine failures on the ground during takeoff run for training purposes must take place below 50% of published VMCA, which is 34 MPH IAS. These engine failures may not be practiced on runways less than 100 feet wide.

The normal practice-area cruise power setting is 21" MP at 2300 RPM.

The zero-thrust setting for simulated single-engine operation is 11" MP at 2000 RPM.

### Revision History

- 10/8/2021: Published after procedure testing.
- 5/15/2022: Updated new empty weight for seat and O2 bottle removal. Updated lighting system.

## QUICK REFERENCE GUIDE

### V-Speeds

V <sub>SO</sub>	67 MPH	Stall speed – Full landing configuration
V <sub>MCA</sub>	67 MPH	Minimum Controllable Airspeed (one engine inop)
V <sub>S1</sub>	73 MPH	Stall speed – Full clean configuration
V <sub>MCA – Flaps 0</sub>	78 MPH	Minimum Controllable Airspeed (one engine inop, flaps up)
V <sub>SSE</sub>	90 MPH	Minimum safe speed for single-engine training maneuvers
V <sub>X</sub>	90 MPH	Best angle-of-climb speed
V <sub>XSE</sub>	90 MPH	Best angle-of-climb speed (one engine inop)
V <sub>Y</sub>	105 MPH	Best rate-of-climb speed
V <sub>YSE</sub>	105 MPH	Best rate-of-climb speed (one engine inop)
V <sub>FE</sub>	125 MPH	Maximum flap extension speed
V <sub>LO - RET</sub>	125 MPH	Maximum landing gear retraction speed
V <sub>LO - EXT</sub>	150 MPH	Maximum landing gear extension speed
V <sub>LE</sub>	150 MPH	Maximum landing gear extended speed
V <sub>A</sub>	133-146 MPH	Maneuvering speed
V <sub>NO</sub>	190 MPH	Maximum structural cruising speed
V <sub>NE</sub>	217 MPH	Never-exceed speed

### Takeoff Performance

*(Assumes no wind/ISA/MTOW/flaps 0)*

	Sea Level	2000' MSL	4000' MSL
Takeoff Over 50' Obstacle	1425 feet	1775 feet	2100 feet
Accelerate-Stop Ground Roll	2000 feet	2300 feet	2600 feet

### Cruise Performance

*(Assumes leaned mixture/ISA/MTOW)*

	RPM	MAP	%PWR	MPH	GPH
3000' MSL	2400	22.2	65	169	18.3
	2400	21.0	60	162	17.2
	2400	19.8	55	156	16.0
6000' MSL	2400	21.5	65	177	18.3
	2400	20.3	60	169	17.2
	2400	19.1	55	162	16.0

Simulated Zero Thrust – All Altitudes	2000	11.0
Cruise Power – Practice Area Maneuvering	2300	21.0

Service Ceiling	17900' MSL
Service Ceiling – One Engine Inoperative	3650' MSL
Absolute Ceiling – One Engine Inoperative	5000' MSL

### Landing Performance

*(Assumes no wind/ISA/MLW/flaps 40)*

	Sea Level	2000' MSL	4000' MSL
Ground Roll	700 feet	740 feet	790 feet
Total to Clear 50' Obstacle	1325 feet	1380 feet	1420 feet

# Weight and Balance Information

N4542T

<b>Basic Empty Weight</b>	<b>3066 lb</b>
<b>Maximum Takeoff Weight</b>	<b>4200 lb</b>
<b>Maximum Landing Weight</b>	<b>4000 lb</b>
Usable Fuel Capacity	93 gal (588 lb)
Front Baggage Compartment Capacity	100 lb
Rear Baggage Compartment Capacity	100 lb
<b>Useful Load – Zero Fuel at MTOW</b>	<b>1134 lb</b>
Available Passenger Load – Full Fuel at MTOW	545 lb

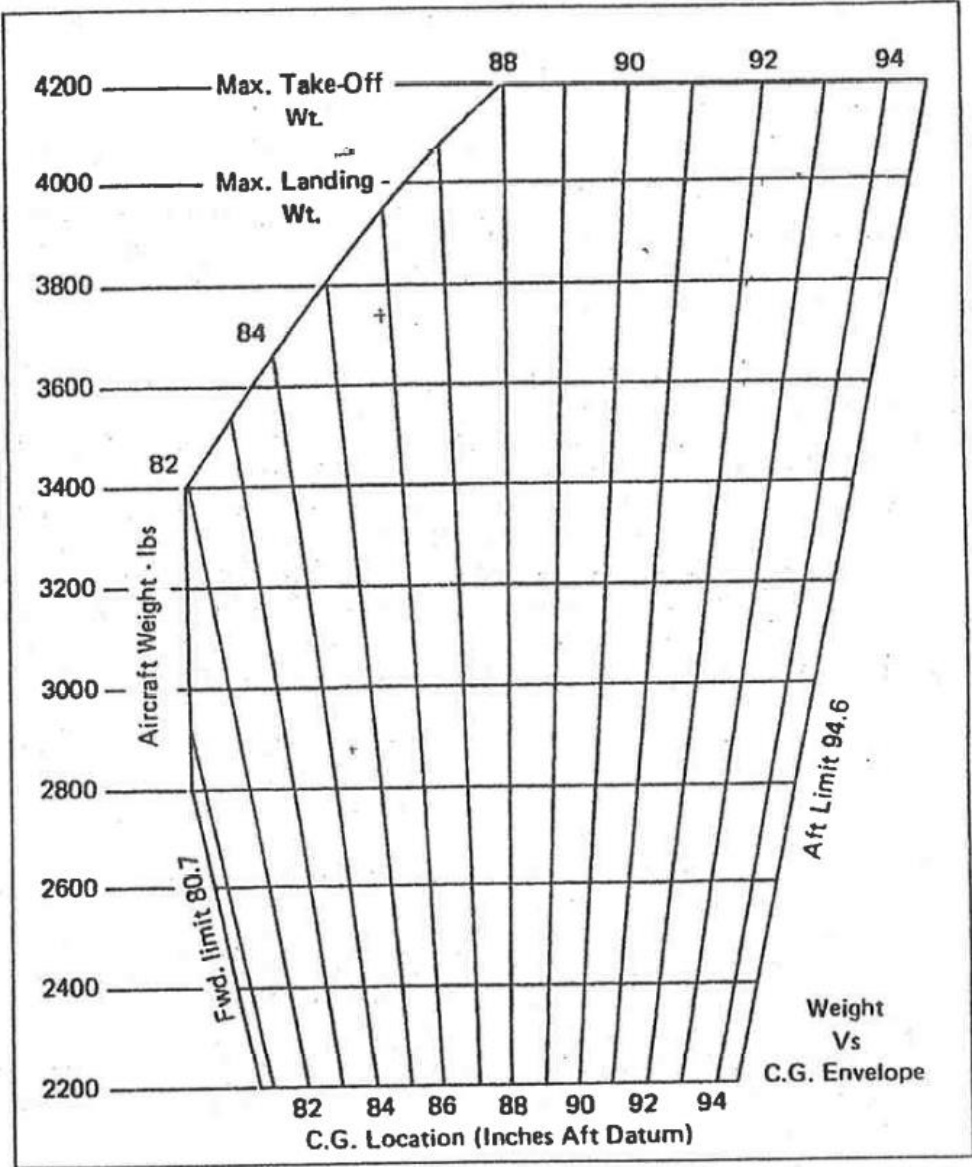

## ACS TASKS – COMMERCIAL MULTIENGINE ADD-ON

Ref: FAA-S-ACS-7A (Commercial ACS) Table A-14 (Addition of Airplane Multiengine Land)

### **I. Preflight Preparation**

- F. Performance and Limitations
- G. Operation of Systems

### **II. Preflight Procedures**

- A. Preflight Assessment
- B. Flight Deck Management
- C. Engine Starting
- D. Taxiing
- F. Before Takeoff Check

### **IV. Takeoffs, Landings and Go-Arounds**

- A. Normal Takeoff and Climb
- B. Normal Approach and Landing
- E. Short-Field Takeoff and Maximum Performance Climb
- F. Short-Field Approach and Landing

### **V. Performance and Ground Reference Maneuvers**

- A. Steep Turns

### **VII. Slow Flight and Stalls**

- A. Maneuvering During Slow Flight
- B. Power-Off Stalls
- C. Power-On Stalls
- D. Accelerated Stalls
- E. Spin Awareness

### **IX. Emergency Operations**

- E. Engine Failure During Takeoff Before VMC
- F. Engine Failure After Liftoff
- G. Approach and Landing with an Inoperative Engine

### **X. Multiengine Operations**

- A. Maneuvering with One Engine Inoperative
- B. VMC Demonstration
- C. One Engine Inoperative during Straight and Level Flight
- D. Instrument Approach and Landing with an Inoperative Engine

## SYSTEMS INFORMATION

### Engines

**Ref:** POH 1-2, 2-2

The Piper Seneca is equipped with two engines. The left engine is a Lycoming IO-360-C1E6. The right engine is a Lycoming LIO-360-C1E6, which is functionally identical except that it spins in the opposite direction of a conventional piston engine, to aid in directional control in the event of an engine loss. For simplicity, both engines will be referred to as the IO-360-C1E6 throughout this manual.

The IO-360-C1E6 is a reciprocating, fuel-injected, four-stroke, manually turbo-normalized, four-cylinder engine, with 360 cubic inches of displacement. It produces 200 brake horsepower at sea level under standard day conditions.

Each engine is equipped with manually operable cowl flaps to aid in engine cooling. These cowl flaps should be open during takeoff and landing to ensure sufficient engine cooling at high power and low airspeed, but can be closed during cruise to maximize true airspeed.

Each engine's ignition is supplied by a dual-redundant magneto system, which does not require electrical power to operate. The engine will keep running normally in the event of an electrical system failure.

The engines are equipped with a Rajay Turbo-Normalizing system, with manual waste gate controls on the throttle quadrant. To increase engine manifold pressure at high altitude, these waste gates can be closed. Use caution to never exceed 25" MAP, and ensure that the waste gates are opened during descent and landing. This system should not be used during multiengine training.

### Fuel System

**Ref:** POH 2-10

The Piper Seneca has two 24.5-gallon fuel tanks in each wing, for a total of 98 gallons of fuel. 5 gallons are unusable, leaving a usable fuel capacity of 93 gallons. Fuel is filled at the outboard tank and feeds to the inboard tank with no input from the pilot.

An engine-driven pump on each engine is the primary means of fuel supply for each engine. An electric auxiliary pump is also available on each engine for redundancy.

Under normal conditions, each wing's fuel system feeds its respective engine. In the event that fuel balancing is required, typically during prolonged single-engine operations, crossfeed selector valves are available for use. Crossfeeding may be used in level flight only (climbing or descending is prohibited). Both fuel selectors should never be in the crossfeed position at the same time in flight.



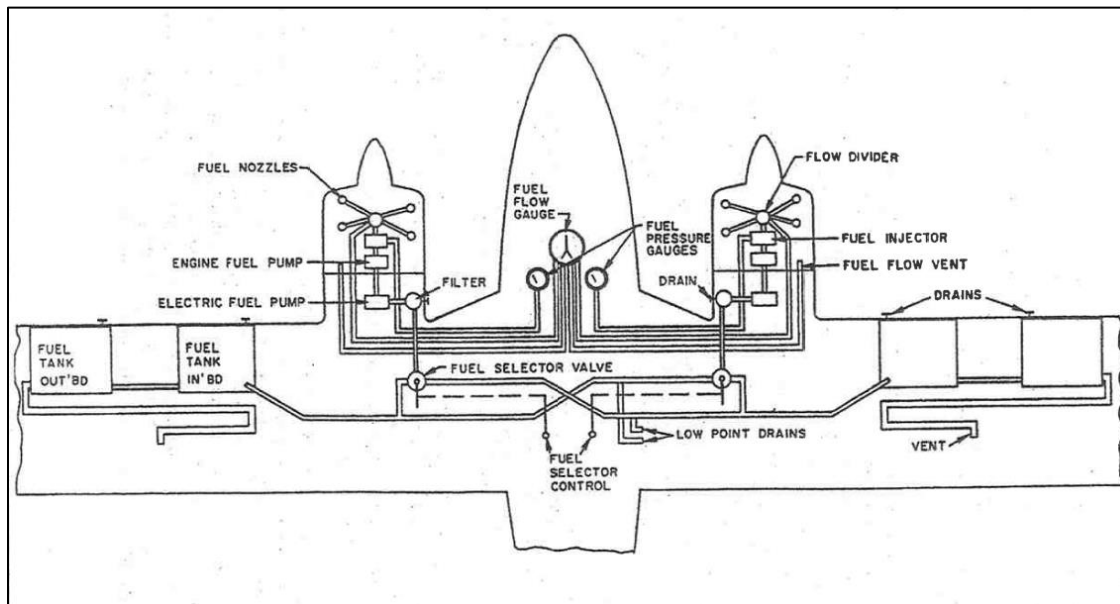

## Propeller System

**Ref:** POH 2-4

Each engine is equipped with a fully-feathering, constant-speed Hartzell propeller. The propeller governor is actuated by oil pressure; an increase in oil pressure will provide a more fine propeller pitch and an increased RPM setting.

A complete loss of oil pressure will cause the propeller to fully feather, to allow maximum drag reduction in the event of an engine failure.

The propellers are equipped with feathering locks that engage at 800 RPM. For this reason, if an engine needs to be feathered, it must be done before the propeller is allowed to slow below 800 RPM.

The Piper Seneca is not equipped with unfeathering accumulators. When an engine restart is required in flight, the starter must be used to windmill the propeller. Do not engage the starter for more than ten seconds at a time, and avoid more than six consecutive duty cycles without a 5-minute cooldown period.

## Electrical System

**Ref:** POH 2-12

The Piper Seneca is powered by a one-battery, dual-alternator electrical system.

The 12-volt, 35-amp-hour battery is located in the nose of the airplane.

The 14-volt alternators are located on the front of each engine, just aft of the spinner. These alternators are protected by voltage regulators and an overvoltage safety relay. They will stop functioning if output exceeds 14 volts. If this occurs, a red Over Voltage light will illuminate next to the alternator master switches, and the corresponding ammeter will read 0.

The electrical system is protected by circuit breakers, eliminating the need for spare fuses to be carried on board at night in accordance with FAR 91.205(c)(6).

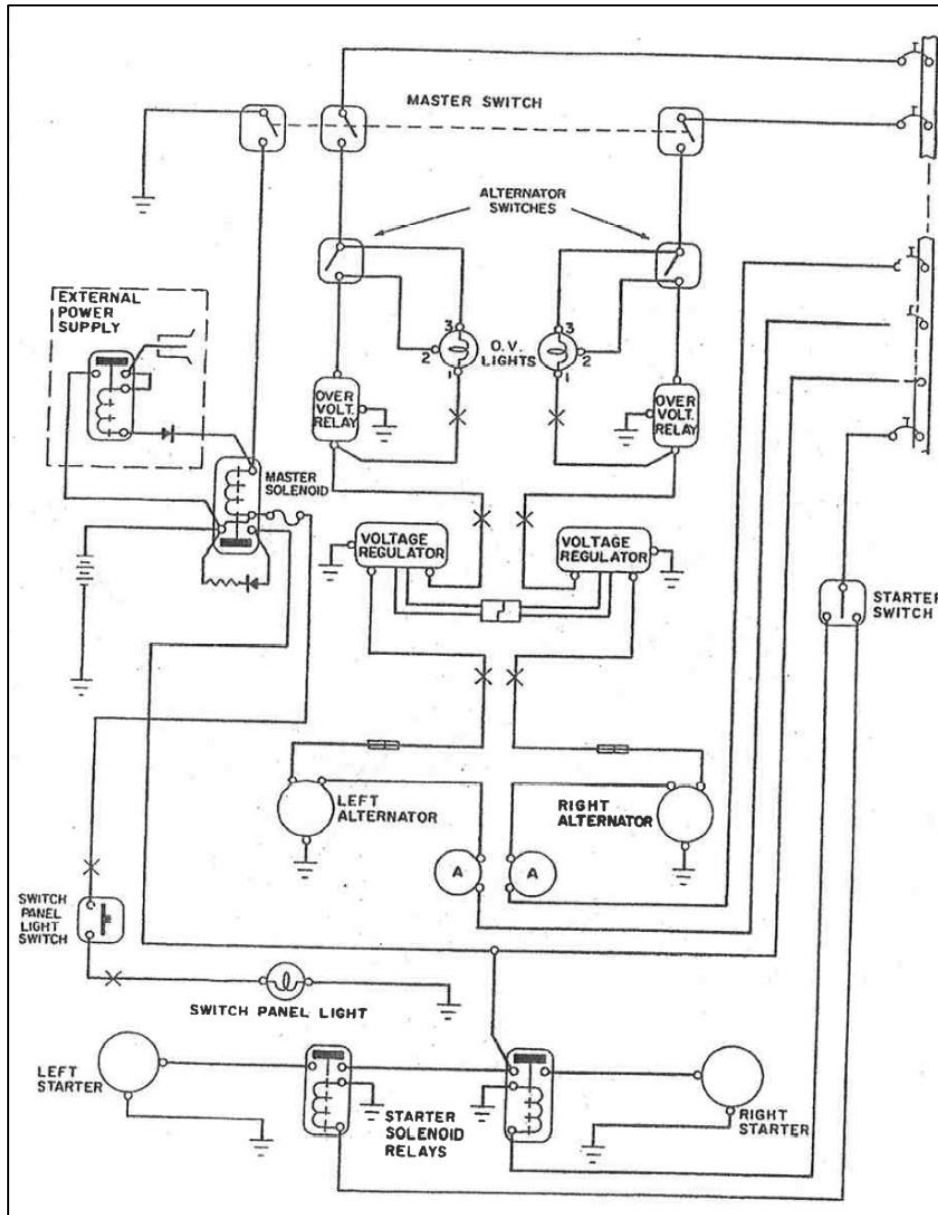

## Landing Gear System

**Ref:** POH 2-4

The Piper Seneca is equipped with retractable landing gear. This system is electrically commanded and hydraulically actuated. Full extension or retraction of the gear takes approximately six to seven seconds, and direction of the gear should not be reversed once it is in transit to avoid damaging the hydraulic pump.

The gear is held in the retracted position by positive hydraulic pressure, and does not have any mechanical up-locks. For this reason, even in the event of a loss of hydraulic pressure or control, the landing gear can still be

extended and locked by following the emergency landing gear extension procedure. The system does have a set of mechanical down-locks, which can be confirmed by the three green indicator lights on the instrument panel.

The system is equipped with a weight-on-wheels safety (“squat”) switch on the left main gear, to prevent the gear from being inadvertently retracted on the ground.

The landing gear system is also equipped with a warning horn, which will sound if the landing gear switch is up on the ground (from the weight-on-wheels switch) or if the throttles are positioned below approximately 12” MAP with the gear retracted.

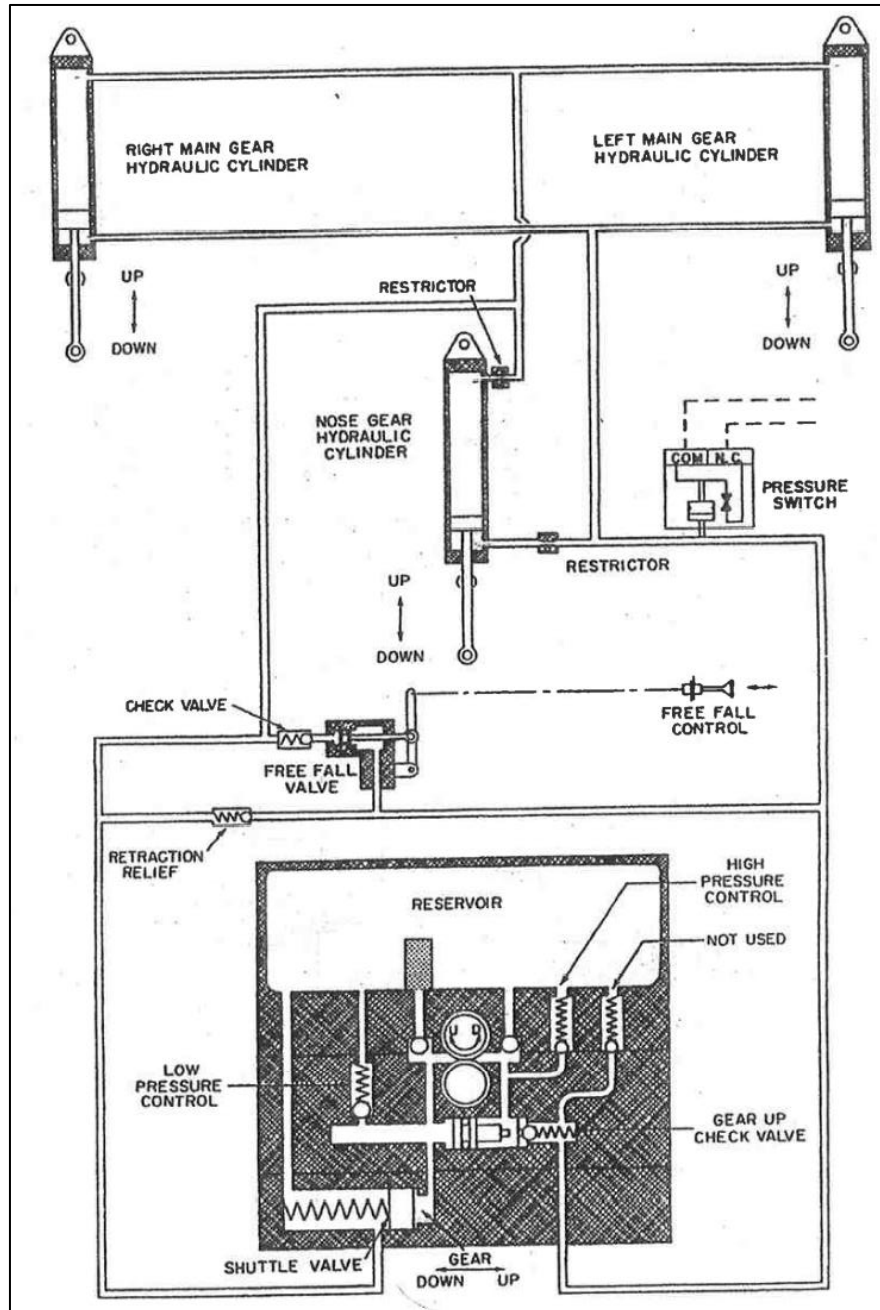

## External Lights

### Navigation (Position) Lights

Navigation lights consist of one rear-facing white light on the rudder, one red light on the left wingtip, and one green light on the right wingtip.

The Seneca's Nav Lights switch also causes the green landing gear position lights to dim. For this reason, the navigation lights should not be turned on unless operating at night or in reduced visibility.

### Beacon Light

The Seneca is equipped with two independently controlled beacon lights. One is a red strobe light on top of the vertical stabilizer, which is controlled by the "Fin" portion of the two-piece Anticollision toggle switch. The other is a white strobe light on the bottom of the fuselage, which is controlled by the "Lower Beacon" switch above the throttle quadrant.

It is a commonly accepted practice in aviation that a flashing red beacon indicates an aircraft with intent to start an engine, if it has not already. When operating or walking around a ramp or parking area, use appropriate vigilance and judgement.

### Strobe (Anticollision) Light

Strobe Lights consist of two white flashbulbs, one on each wingtip. They should be used in conjunction with the Beacon light, except when taxiing at night. During these conditions, turn strobe lights off to avoid blinding others.

In the Seneca, this light switch is labeled as the "Wing" portion of the two-piece Anticollision toggle switch. While operating in IMC after dark, consider turning off strobe lights to prevent blinding induced by reflection. The Seneca is also equipped with a Bottom Strobe switch, which activates a separate white flashing beacon on the underside of the airplane. This light is encouraged to be turned on before takeoff during day VFR operation.

### Landing Light

The landing light is a forward-facing white light, angled to provide optimal visibility during a takeoff or an approach to landing. It is mounted on the nose landing gear.

### Taxi Light

The taxi light is another forward-facing white light, but angled further down to provide optimal visibility during taxi. It is mounted on the nose landing gear. It is controlled by the left side of the two-part "Recog" switch.

### Recognition Lights

The recognition lights are two forward-facing white lights, one on each wingtip, intended to augment the landing lights and increase forward visibility.

In the Seneca, these are controlled by the right side of the two-part "Recog" switch.

The Seneca is also equipped with a pulse light system, which will automatically alternate between the two recognition lights. This system will only function if the corresponding Recog switch is off. Using the pulse lights during day VFR operation is highly encouraged for maximum visibility.

## Lighting Guide

The following is a set of recommended lighting configurations for various operating conditions.

### Engine Start

**Day:** Anticollision Fin/Wing On

**Night:** Anticollision Fin On, Wing Off, Nav On

### After Start

**All:** Landing Light On

### Before Takeoff

**Day:** Pulse Light On, Bottom Strobe On

**Night:** Recog Lights On, Anticollision Wing On, Bottom Strobe On

### Climb

**All:** Landing Light Off

### Approach

**All:** Landing Light On

### After Landing

**Day:** Pulse Light Off, Bottom Strobe Off

**Night:** Recog Lights Off (or as reqd for taxi), Anticollision Wing Off, Bottom Strobe Off

## COMMON TASKS

### Traffic Pattern Arrival

**Ref:** AFH Ch. 7, AC 90-66B

**Objective:** To safely and efficiently arrive at an airport and perform traffic pattern operations.

1. Complete the Approach Checklist.
2. At least 10nm from the airport, attempt to determine the runway in use\*.
3. At least 2nm from the runway, enter the traffic pattern at the published Traffic Pattern Altitude on a 45-degree entry to the downwind leg, maintaining a ½-mile distance from the runway once established.
  - a. If approaching from the opposite side of the airport, overfly the airport at least 500' above Traffic Pattern Altitude.
4. Complete the Before Landing Checklist.

The above procedure assumes an ideal traffic pattern situation. Other traffic, ATC, local traffic pattern restrictions, obstacles, etc may require a modification of these procedures. In all cases, the pilot shall exercise good judgement and maintain positive airplane control.

\* If the runway in use cannot be determined, overfly the airport at least 500' above Traffic Pattern Altitude to observe traffic and/or wind direction indicators to determine a runway for use.

#### **Standards**

Maintain proper spacing from other aircraft.

Maintain orientation with landing runway.

Maintain traffic pattern altitude +/- 50' and +/- 10 MPH.

## Traffic Pattern Departure

**Ref:** AFH Ch. 7, AC 90-66B

**Objective:** To safely depart an airport after takeoff or integrate into the flow of traffic when remaining in the traffic pattern.

If departing the traffic pattern...

1. Climb straight out on runway heading until above traffic pattern altitude, or...
2. Exit with a 45-degree turn to the left (assuming left-hand traffic) beyond the departure end of the runway, OR exit on the downwind leg once above traffic pattern altitude.
3. Complete the Climb Checklist.

If remaining in the traffic pattern...

1. Begin a turn to the crosswind leg when beyond the departure end of the runway and within 300 feet of Traffic Pattern Altitude.

The above procedure assumes an ideal traffic pattern situation. Other traffic, ATC, local traffic pattern restrictions, obstacles, etc may require a modification of these procedures. In all cases, the pilot shall exercise good judgement and maintain positive airplane control.

### **Standards**

Maintain proper spacing from other aircraft.

Maintain orientation with runway.

Maintain traffic pattern altitude +/- 50' and +/- 10 MPH.

# Traffic Pattern Quick Reference

Rotate	80 MPH
Pattern Departure	105-120 MPH
Upwind	105 MPH [V <sub>Y</sub> ]
Downwind	110 MPH
Base	100 MPH
Final	90 MPH

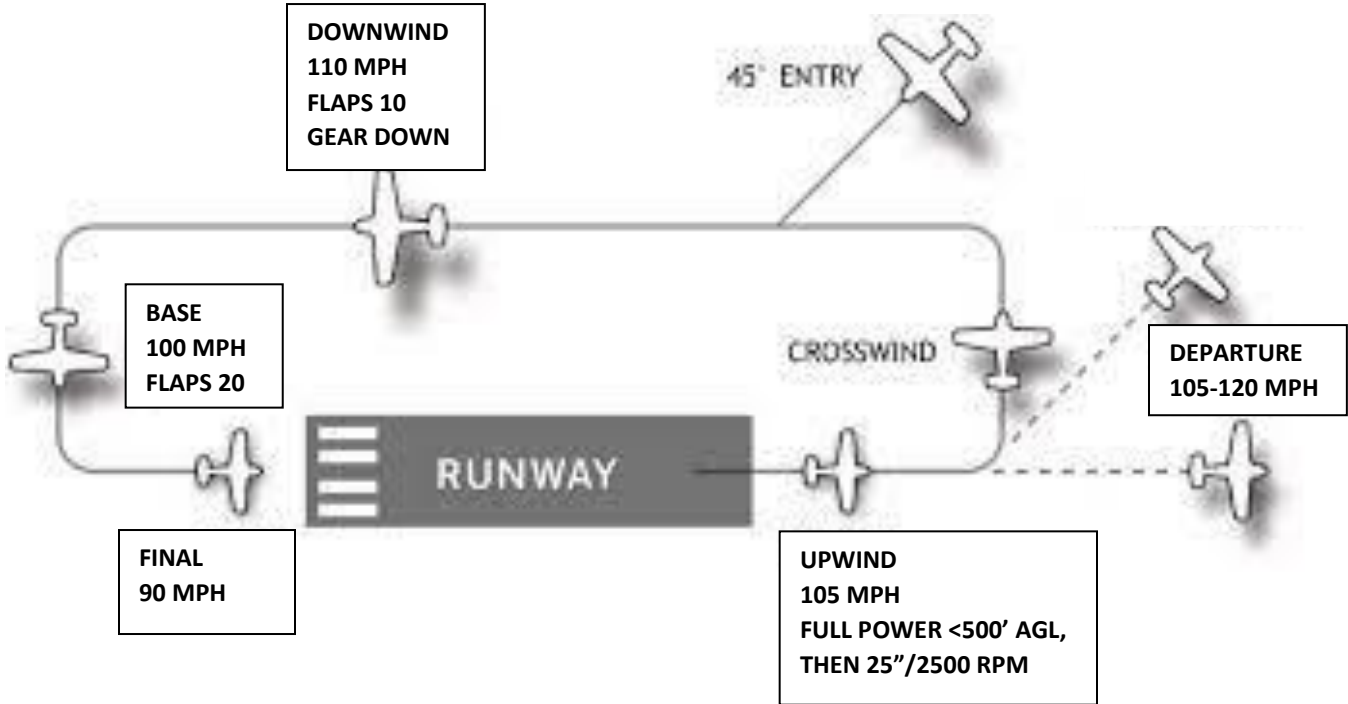



## Clearing Turns

**Ref:** AIM Sec. 4

**Objective:** To observe any local threats or hazards, including obstacles or other traffic, prior to commencing any training maneuver.

1. Visually scan the area to the left and right of the aircraft.
2. Select a visual landmark off the wingtip in the direction of the turn to be executed as a 90-degree reference point.
3. Enter a 30-degree bank in the direction of the visual landmark.
4. Continuously scan the area above, below, and ahead of the flight path.
5. After completing a 90-degree turn, roll wings level on the selected landmark.
6. Select another visual landmark off the opposite wingtip in the direction of the next 90-degree turn.
7. Enter a 30-degree bank in the direction of the visual landmark.
8. Continuously scan the area above, below, and ahead of the flight path.
9. After completing the second 90-degree turn, roll wings level on the selected landmark. The aircraft should now be on its original heading.

Note: Clearing turns do not absolve a pilot of his/her responsibility to see and avoid traffic while performing training maneuvers.

## Configuring the Aircraft for Maneuvers

Prior to commencing any maneuvers, the following configuration settings should be considered. Recommendations are offered below for individual maneuvers.

### **BOOST/FUEL PUMP**

The Boost Pumps should be used during takeoff, landing, and any training maneuvers.

### **CARBURETOR HEAT**

The Piper Seneca is not equipped with carburetors.

### **GAS/FUEL TANKS**

The fuel selector should be set to the normal position. Crossfeed should never be used during maneuvers.

### **UNDERCARRIAGE/LANDING GEAR**

If required by the maneuver, the landing gear should be confirmed in the down-and-locked position.

### **MIXTURE**

Mixture should always be set to full rich for maneuvers.

### **POWER/PROPELLER**

Engine power and/or propeller RPM should be set as needed for the maneuver to be performed.

### **SEAT BELTS**

All occupants' seat belts should be fastened at all times, and any baggage that may shift during maneuvers should be secured with seat belts if possible.

### **SWITCHES**

All aircraft lights should be on for maneuvers. Additionally, pitot heat should be used if entering instrument conditions or in any form of visible moisture.

The preceding configuration can be accomplished by following the acronym: **BCGUMPSS**

**B**oost Pump

**C**arburetor Heat

**G**as

**U**ndercarriage

**M**ixture

**P**ower

**S**eat belts

**S**witches

# TAKEOFFS AND LANDINGS

## Normal Takeoff and Climb

**Ref:** POH 6-7, AFH 5-3

**Objective:** To safely execute a takeoff under normal conditions.

1. Complete the Before Takeoff Checklist.
2. Center the aircraft on the runway centerline with the nose wheel straight ahead.
3. Advance the throttles to 18" MAP. Hold brakes if required to prevent rolling forward.
4. When both engine gauges indicate symmetrically at 18" MAP, call out "Stable".
5. Advance the throttle to full power.
6. Check engine instruments as power increases.
7. When airspeed indicator begins moving, call out "Airspeed Alive".
8. Accelerate aircraft to 80 MPH.
9. Increase back pressure on the control yoke to pitch up until the glare shield meets the horizon (approximately 10 degrees nose-up).
10. When a positive rate of climb is confirmed, call out "Positive Rate" and retract the landing gear.
11. When clear of obstacles, retract flaps.
12. Accelerate to 105 MPH [V<sub>Y</sub>] and climb on centerline. Trim as necessary.
13. Above 500 feet AGL, set throttle and propeller to climb power (25" MAP, 2500 RPM).

If departing the pattern...

14. Execute a Traffic Pattern Departure procedure as applicable.
15. Above 1000' AGL, complete the Climb Checklist.

If remaining in the pattern...

16. Begin a turn to the crosswind leg when beyond the departure end of the runway and within 300 feet of Traffic Pattern Altitude.

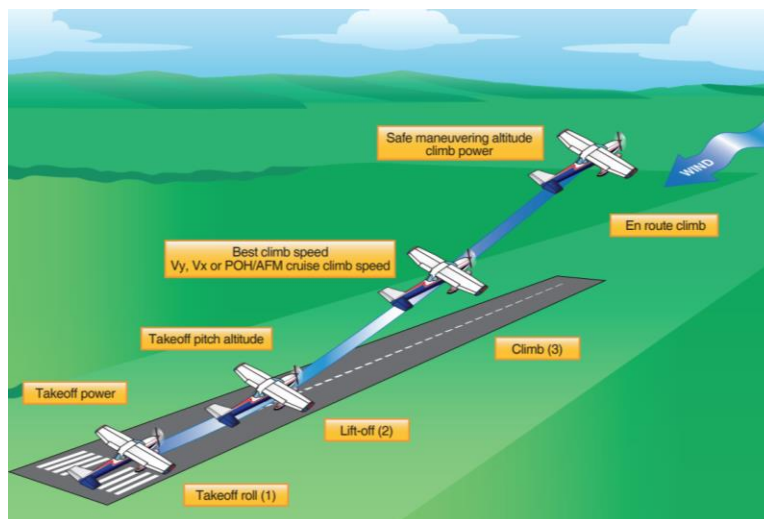

### Standards

Maintain airspeed +5/-5 MPH from V<sub>Y</sub>.

## Crosswind Takeoff and Climb

**Ref:** POH AFH 5-6

**Objective:** To safely execute a takeoff in crosswind conditions.

1. Complete the Before Takeoff Checklist.
2. Center the aircraft on the runway centerline with the nose wheel straight ahead.
3. Position flight controls for the wind conditions (ailerons into the wind).
4. Advance the throttles to 18" MAP. Hold brakes if required to prevent rolling forward.
5. When both engine gauges indicate symmetrically at 18" MAP, call out "Stable".
6. Advance the throttle to full power.
7. Check engine instruments as power increases.
8. When airspeed indicator begins moving, call out "Airspeed Alive".
9. Throughout the takeoff roll, gradually reduce aileron input as required.
10. Accelerate aircraft to 80 MPH.
11. Increase back pressure on the control yoke to pitch up until the glare shield meets the horizon (approximately 10 degrees nose-up).
12. When a positive rate of climb is confirmed, call out "Positive Rate" and retract the landing gear.
13. When clear of obstacles, retract flaps.
14. Accelerate to 105 MPH [Vy] and climb on centerline. Trim as necessary.
15. Above 500 feet AGL, set throttle and propeller to climb power (25" MAP, 2500 RPM).

If departing the pattern...

1. Execute a Traffic Pattern Departure procedure as applicable.
2. Above 1000' AGL, complete the Climb Checklist.

If remaining in the pattern...

3. Begin a turn to the crosswind leg when beyond the departure end of the runway and within 300 feet of Traffic Pattern Altitude.

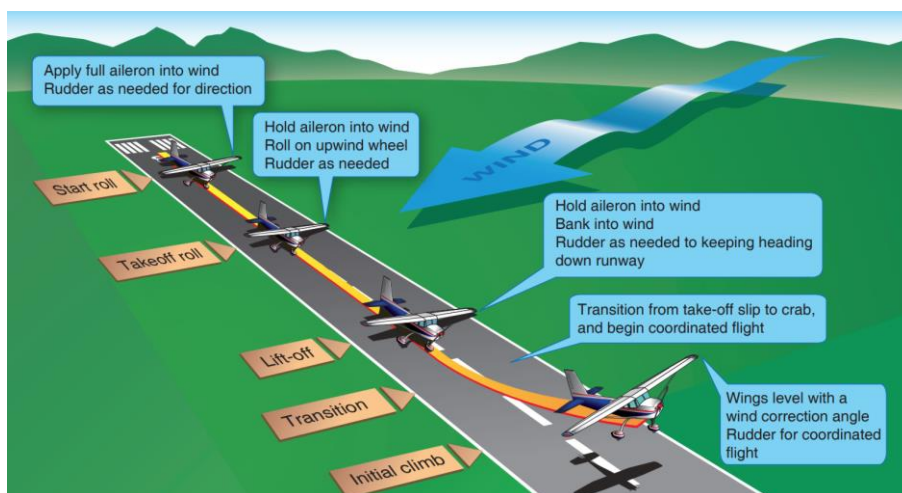

### Standards

Maintain airspeed +5/-5 MPH from Vy.

## Short Field Takeoff

**Ref:** POH 6-7, AFH 5-10

**Objective:** To obtain maximum performance during takeoff and minimize runway length required.

1. Complete the Before Takeoff Checklist with the flaps set to 20 degrees.
2. Center the aircraft on the runway centerline with the nose wheel straight ahead. Use all available runway surface.
3. Firmly press and hold both brake pedals.
4. Advance the throttles to 18" MAP. Hold brakes to prevent rolling forward.
5. When both engine gauges indicate symmetrically at 18" MAP, call out "Stable".
6. Advance the throttle to full power.
7. Check engine instruments as power increases.
8. When airspeed indicator begins moving, call out "Airspeed Alive".
9. Accelerate aircraft to 80 MPH.
10. Increase back pressure on the control yoke to pitch for an initial climb speed of 90 MPH [V<sub>x</sub>].
11. When a positive rate of climb is confirmed, call out "Positive Rate" and retract the landing gear.
12. When clear of obstacles, retract flaps.
13. Accelerate to 105 MPH [V<sub>y</sub>] and climb on centerline. Trim as necessary.
14. Above 500 feet AGL, set throttle and propeller to climb power (25" MAP, 2500 RPM).

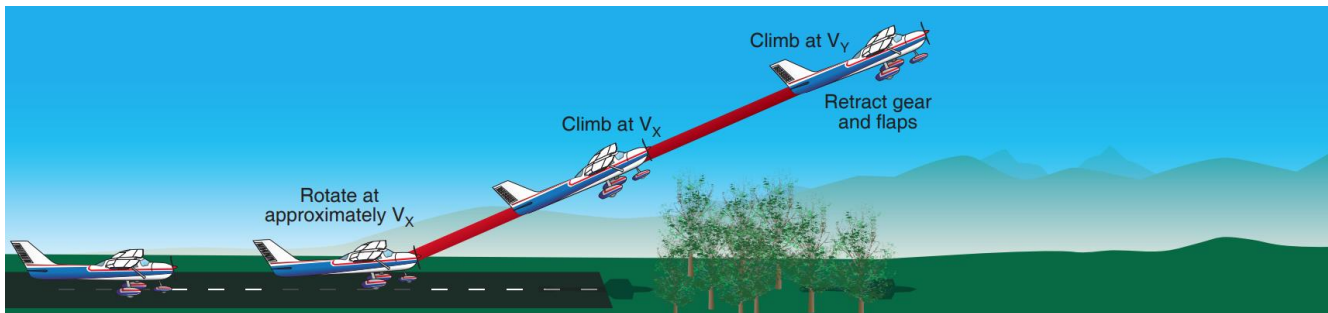

### Standards

Maintain airspeed +5/-5 MPH from V<sub>x</sub>/V<sub>y</sub>.

## Takeoff Briefing

Prior to takeoff in a multiengine airplane, a takeoff briefing must be performed. This briefing will cover all possible outcomes of an engine failure during the takeoff and/or departure.

### **If an engine fails...**

#### **Below rotation speed (80 MPH)**

- Immediately close both throttles and apply maximum braking to stop the aircraft on the runway.
- Pilot flying is responsible for exiting the runway promptly and safely, if able.
- Pilot monitoring is responsible for radio communications.

#### **After takeoff with landing gear still extended and usable runway remaining**

- Immediately close both throttles and land on remaining runway. Upon landing, apply maximum braking.
- Pilot flying is responsible for landing and exiting the runway promptly and safely, if able.
- Pilot monitoring is responsible for radio communications.

#### **After takeoff with landing gear retracted and/or no usable runway remaining**

- Discuss backup plan regarding local airports with suitable instrument approaches and/or long runways if needed.
- Consider whether it is safe to return to the departure airport on a single engine.

## Normal Approach and Landing

**Ref:** POH 6-10, AFH 8-2

**Objective:** To safely and accurately establish and maintain a stabilized approach to a landing.

1. Complete the Before Landing checklist.
2. Enter the traffic pattern as described in this manual – see Traffic Pattern Arrival.
3. Abeam the point of intended landing on downwind, reduce throttles to 18" MAP and allow the airplane to begin descending at 110 MPH.
4. Set flaps to 10 degrees.
5. Set propellers to full forward.
6. Extend the landing gear.
7. When the touchdown point is 45 degrees to the rear of the wing root (or as appropriate for wind conditions), turn to the base leg.
8. Slow the aircraft to 100 MPH and extend flaps to 20 degrees. Continue to maintain appropriate descent rate (500-700 fpm) and adjust power if necessary.
9. Visually verify that the final approach (including the extended centerline and the opposite base) is clear of traffic, then turn to final.
10. Maintain 90-95 MPH on final approach (+ ½ gust factor, if applicable). Trim for minimum control input on a stable descent to the runway.
11. When landing on runway is assured, reduce power to idle. Keep the nose of the airplane at or below level until within 10 feet of the ground.
12. When in close proximity to the runway, pitch the nose up so that the main wheels will touch down prior to the nose wheel. Allow the aircraft to settle gently.
13. Maintain directional control on centerline with rudders throughout flare, landing and rollout.
14. Apply brakes as necessary. Ensure that the airplane is slower than 10 MPH before turning onto a taxiway.

**NOTE:** If the approach is unstable at or below 200' AGL, execute a go-around.

**NOTE:** Multiengine airplanes will suffer a noticeable loss of lift when both throttles are set to idle. Pilots accustomed to single-engine aircraft may tend to reduce power too early, causing instability on the approach.

**NOTE:** Landing with the flaps set to 40 degrees is not recommended for normal landings due to decrease in roll control at low speed.

### **Standards**

Maintain airspeed +5/-5 MPH.

Touch down within 200 feet of landing point.

## Crosswind Approach and Landing

**Ref:** POH 6-11, AFH 8-14

**Objective:** To safely and land the aircraft during crosswind conditions.

1. Complete the Before Landing checklist.
2. Enter the traffic pattern as described in this manual – see Traffic Pattern Arrival.
3. Abeam the point of intended landing on downwind, reduce throttle to 18" MAP and allow the airplane to begin descending at 110 MPH.
4. Set flaps to 10 degrees.
5. Set propellers to full forward.
6. Extend the landing gear.
7. When the touchdown point is 45 degrees to the rear of the wing root (or as appropriate for wind conditions), turn to the base leg.
8. Slow the aircraft to 100 MPH and extend flaps to 20 degrees. Continue to maintain appropriate descent rate (500-700 fpm) and adjust power if necessary.
9. Visually verify that the final approach (including the extended centerline and the opposite base) is clear of traffic, then turn to final.
10. Maintain 90-95 MPH on final approach (+ ½ gust factor, if applicable). Trim for minimum control input on a stable descent to the runway.
11. Use aileron to lower the upwind wing on final, and use rudder to keep airplane on extended centerline. This will result in a slightly cross-controlled "slip" style input.
12. When landing on runway is assured, reduce power to idle. Keep the nose of the airplane at or below level until within 10 feet of the ground. Keep upwind wing slightly low and maintain centerline with rudder input.
13. When in close proximity to the runway, pitch the nose up so that the main wheels will touch down prior to the nose wheel. Allow the aircraft to settle gently on the upwind main wheel first, then the downwind main wheel, then the nosewheel.
14. Maintain directional control on centerline with rudders throughout flare, landing and rollout. Use aileron input to maintain wings level through rollout.
15. Apply brakes as necessary. Ensure that the airplane is slower than 10 MPH before turning onto a taxiway.

### Standards

Maintain airspeed +5/-5 MPH.

Touch down within 200 feet of landing point.



## Short Field Approach and Landing

**Ref:** POH 6-11, AFH 8-18

**Objective:** To safely land the aircraft in the shortest distance possible.

1. Complete the Before Landing checklist.
2. Enter the traffic pattern as described in this manual – see Traffic Pattern Arrival.
3. Abeam the point of intended landing on downwind, reduce throttles to 18" MAP and allow the airplane to begin descending at 110 MPH.
4. Set flaps to 10 degrees.
5. Set propellers to full forward.
6. Extend the landing gear.
7. When the touchdown point is 45 degrees to the rear of the wing root (or as appropriate for wind conditions), turn to the base leg.
8. Slow the aircraft to 100 MPH and extend flaps to 25 degrees. Continue to maintain appropriate descent rate (500-700 fpm) and adjust power if necessary.
9. Visually verify that the final approach (including the extended centerline and the opposite base) is clear of traffic, then turn to final.
10. Set flaps to 40 degrees.
11. Maintain 90 MPH on final approach (+ ½ gust factor, if applicable). Trim for minimum control input on a stable descent to the runway.
12. When landing on runway is assured, reduce power to idle. Keep the nose of the airplane at or below level until within 10 feet of the ground.
13. When in close proximity to the runway, pitch the nose up so that the main wheels will touch down prior to the nose wheel. Allow the aircraft to settle gently.
14. Maintain directional control on centerline with rudders throughout flare, landing and rollout.
15. Apply maximum braking without locking the wheels. Additional aerodynamic braking can be accomplished by holding back elevator pressure.

NOTE: If the approach is unstable at or below 200' AGL, execute a go-around.

NOTE: The manufacturer allows retracting the flaps during landing roll for maximum short-field braking ability. This procedure shall not be performed for training purposes.

NOTE: 87 MPH is equal to 1.3x V<sub>so</sub>, which is the recommended short field approach speed (AFH 8-3).

### Standards

Maintain airspeed +5/-5 MPH.

Touch down within 100 feet of landing point.

## Go-Around/Balked Landing

**Ref:** AFH 8-12

**Objective:** To safely abandon a landing and climb away from the runway, to return to the traffic pattern.

1. Apply full throttle to initiate the go-around procedure. Maintain at least 67 MPH [VMCA] at all times.
2. Pitch the aircraft's nose up to establish a positive rate of climb.
3. When a positive rate of climb is confirmed, call out "Positive Rate" and retract the landing gear.
4. Retract flaps to 25 degrees.
5. Maintain a climb speed of at least 90 MPH [V<sub>x</sub>].
6. When clear of obstacles, accelerate to 105 MPH [V<sub>y</sub>].
7. When obstacles are clear, retract remaining flaps slowly.
8. Above 500 feet AGL, set throttle and propeller to climb power (25" MAP, 2500 RPM).
9. Follow departure procedures listed in this manual (see "Traffic Pattern Departure") as appropriate.

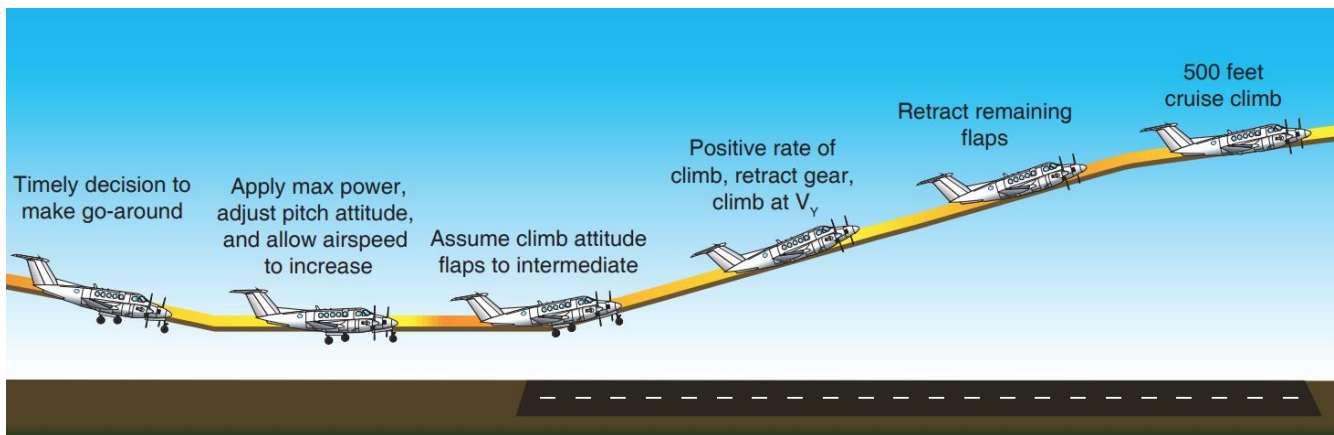

### Standards

Apply takeoff power immediately and transition to climb pitch attitude for V<sub>x</sub> or V<sub>y</sub> as appropriate +5/-5 MPH.

## PERFORMANCE MANEUVERS

### Steep Turns

**Ref:** AFH 9-2

**Objective:** To safely perform turns at 50 degrees of bank while maintaining controlled flight.

1. Complete clearing turns and configure the airplane for maneuvering.
2. Establish airspeed of 130 MPH and trim as necessary for level flight.
3. Choose a prominent landmark straight ahead and/or note current aircraft heading.
4. Roll into a 50-degree bank in your direction of choice and begin a 360-degree turn.
5. Add power as required to maintain altitude and airspeed. A typical power setting for this maneuver is 23" MAP and 2300 RPM if the cowl flaps are open.
6. If necessary, use nose-up pitch input and/or trim to maintain altitude.
7. Begin rolling the wings level approximately 15-20 degrees prior to the original landmark or heading. They should be level upon reaching the original heading.
8. Immediately roll into a 50-degree bank to begin a 360-degree turn in the opposite direction. Be careful to maintain altitude while rolling through wings level by using nose-down input or trim as applicable.
9. Begin rolling the wings level approximately 15-20 degrees prior to the original landmark or heading. They should be level upon reaching the original heading.
10. Return to cruise power.

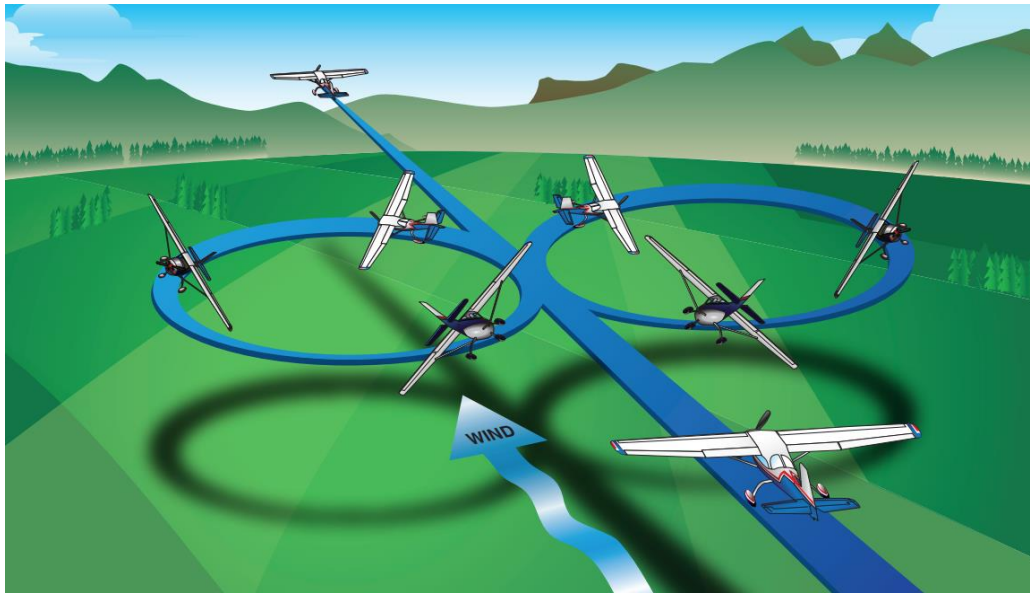

#### **Standards**

Maintain airspeed +/-10 MPH.

Maintain altitude +/-100 feet.

## Slow Flight

**Ref:** AFH 4-3

**Objective:** To maintain flight at the aircraft's minimum controllable airspeed.

1. Complete clearing turns and configure the airplane for maneuvering.
2. Reduce throttle to 15" MAP to begin slowing the airplane.
3. As the airplane's speed decreases, use nose-up trim to maintain altitude.
4. When below 150 MPH [V<sub>LE</sub>], extend the landing gear.
5. Gradually increase propellers to full forward RPM, ensuring not to exceed redline (2700 RPM).
6. When below 125 MPH [V<sub>FE</sub>], gradually extend flaps to 20 degrees. Use trim to maintain altitude.
7. Slow to a speed just above the first indication of a stall (about 80 MPH).
8. Upon reaching the target speed, add power to maintain altitude.
9. Use pitch to make minor corrections in airspeed, while continuing to use throttle to make minor corrections in altitude.

To recover...

10. Add full throttle. Use trim to maintain altitude.
11. When a positive rate of climb is confirmed, retract landing gear.
12. Gradually retract flaps. Use caution not to exceed 125 MPH [V<sub>FE</sub>].
13. When flaps are fully retracted, return to cruise power.

**NOTE:** This maneuver may involve prolonged flight near or below VMCA. In the event of an engine failure, this maneuver must be discontinued immediately and the airspeed increased to at least 67 MPH [VMCA] to maintain control.



### Standards

Maintain airspeed +5/-0 MPH from V<sub>SO</sub>.

Maintain altitude +/-50 feet.

Maintain heading +/-10 degrees.

## Power-On Stall

**Ref:** AFH 4-9

**Objective:** To demonstrate and safely recover from the power-on stall characteristics of the aircraft.

1. Complete clearing turns and configure the airplane for maneuvering.
2. Reduce throttle to 15" MAP to begin slowing the airplane.
3. As the airplane's speed decreases, use nose-up trim to maintain altitude.
4. Gradually increase propellers to full forward RPM, ensuring not to exceed redline (2700 RPM).
5. When the airplane slows to approximately 90 MPH, set throttles to 21" MAP.
6. Establish a pitch up attitude to induce a stall indication (approximately 15 degrees).

To recover...

1. At the first indication of a stall, immediately reduce the angle of attack by using forward pressure to lower the nose.
2. When aircraft is stable, return to cruise power.

**NOTE:** This maneuver may be practiced at full power as desired by the instructor/examiner.

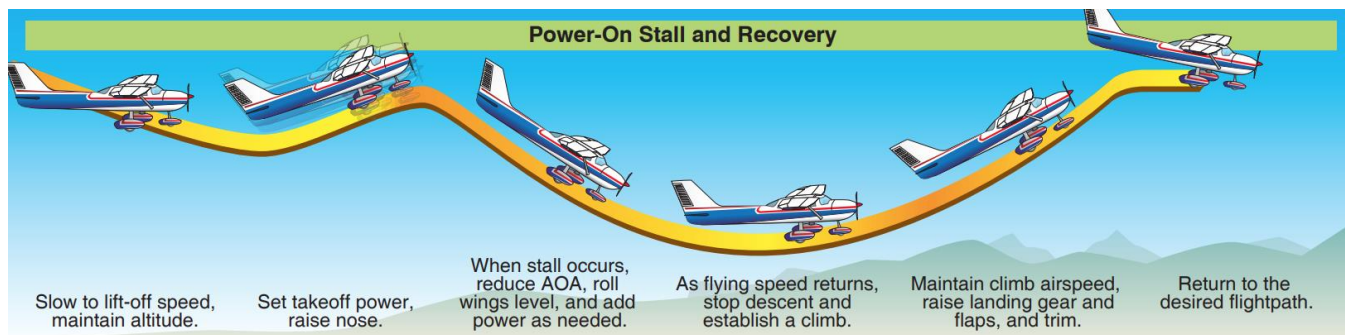

### Standards

Maintain heading +/-10 degrees.

Maintain angle of bank (if specified) +/-10 degrees.

Recover promptly after the first indication of a stall.

## Power-Off Stall

**Ref:** AFH 4-8

**Objective:** To demonstrate and safely recover from the power-off stall characteristics of the aircraft.

1. Complete clearing turns and configure the airplane for maneuvering.
2. Reduce throttle to 15" MAP to begin slowing the airplane.
3. As the airplane's speed decreases, use nose-up trim to maintain altitude.
4. When below 150 MPH [V<sub>LE</sub>], extend the landing gear.
5. Gradually increase propellers to full forward RPM, ensuring not to exceed redline (2700 RPM).
6. When below 125 MPH [V<sub>FE</sub>], gradually extend flaps to 20 degrees. Use trim to maintain altitude.
7. Establish a glide similar to a final approach around 500 feet per minute.
8. Reduce throttles to idle and raise pitch to induce stall indication.

To recover...

9. At the first indication of a stall, immediately apply full power and reduce the angle of attack by using forward pressure to lower the nose.
10. When a positive rate of climb is confirmed, retract landing gear.
11. Gradually retract flaps. Use caution not to exceed 125 MPH [V<sub>FE</sub>].
12. When flaps are fully retracted, return to cruise power.

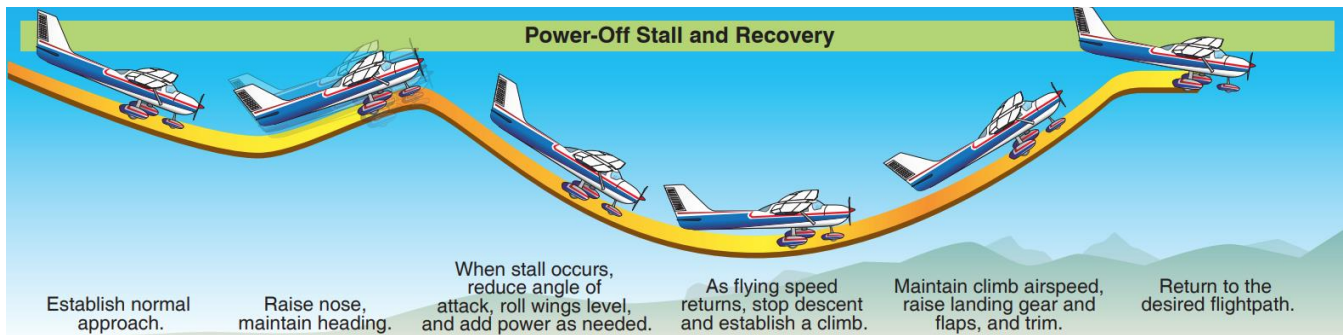

### Standards

Maintain heading +/-10 degrees.

Maintain angle of bank (if specified) +/-5 degrees.

Recover promptly after the first indication of a stall.

## Accelerated Stall

**Ref:** AFH 4-10

**Objective:** To recognize the relationship between bank, angle of attack, and stall speed.

1. Complete clearing turns and configure the airplane for maneuvering.
2. Reduce throttle to 15" MAP to begin slowing the airplane.
3. As the airplane's speed decreases, use nose-up trim to maintain altitude.
4. Gradually increase propellers to full forward RPM, ensuring not to exceed redline (2700 RPM).
5. When the airplane slows to approximately 100 MPH, promptly enter a turn at 45 degrees of bank.
6. Use a strong pitch-up control input to induce a stall indication.

To recover...

1. Immediately release back pressure to decrease angle of attack.
2. Roll the wings level.
3. Return to cruise power.

### Standards

Recover promptly at the first indication of a stall.

## Demonstration of VMCA

**Ref:** AFH 12 Addendum

**Objective:** To demonstrate the single-engine handling abilities of the aircraft at low speed and high power.

1. Complete clearing turns and configure the airplane for maneuvering.
2. Reduce throttle to 15" MAP to begin slowing the airplane.
3. Choose one engine to be designated as the "critical" engine, and close that engine's cowl flap.
4. As the airplane's speed decreases, use nose-up trim to maintain altitude.
5. Gradually increase propellers to full forward RPM, ensuring not to exceed redline (2700 RPM).
6. Set the designated critical engine's throttle to idle.
7. Gradually increase the opposite engine's throttle to full, while maintaining directional control as required. Pitch to establish controlled flight at 105 MPH [V<sub>YSE</sub>].
8. Increase pitch angle such that indicated airspeed begins to slowly decrease. Maintain directional control with rudder and no more than 5 degrees of bank towards the operating engine.
9. Begin recovery process at the first indication of either a stall or a loss of directional control.

To recover...

10. Idle the operating engine's throttle.
11. Immediately pitch the nose down to reduce angle of attack and increase airspeed, in order to regain directional control.
12. When directional control is regained and stall indications have stopped, apply full throttle on the operating engine.
13. Establish a climb at 105 MPH [V<sub>YSE</sub>]. Maintain directional control.
14. Return to cruise power.

**NOTE:** The Piper Seneca does not have a critical engine, which allows the pilot or examiner to choose an engine for this demonstration. Both should perform identically in this maneuver. If this maneuver is performed multiple times in a single training session, engine selection should be alternated to minimize wear.



## Demonstration of Drag

**Ref:** AFH 12

**Objective:** To demonstrate the drag effects and climb capability of various aircraft configurations on a single engine.

*This maneuver will be for demonstration purposes only, unless in the case of an MEI candidate.*

1. Complete clearing turns and configure the airplane for maneuvering.
2. Choose one engine to be designated as the “critical” engine, and close that engine’s cowl flap.
3. Set both propellers to full forward RPM.
4. Reduce the “critical” engine’s throttle to idle.
5. Increase the operating engine’s throttle to full, while maintaining directional control.
6. Establish controlled flight at 105 MPH [V<sub>YSE</sub>] and continue to maintain that speed throughout the maneuver. Note current vertical speed.
7. Extend the landing gear. Note resulting vertical speed.
8. Extend the flaps. Note resulting vertical speed.
9. Retract the landing gear, leaving flaps extended. Note resulting vertical speed.
10. Retract flaps and return to cruise power.

NOTE: The Piper Seneca does not have a critical engine, which allows the pilot or examiner to choose an engine for this demonstration. Both should perform identically in this maneuver. If this maneuver is performed multiple times in a single training session, engine selection should be alternated to minimize wear.

## INSTRUMENT FLIGHT

### Recovery From Unusual Attitudes

**Ref:** AFH 4-17

**Objective:** To safely recover the aircraft from an unusual flight attitude induced by spatial disorientation.

1. Scan primary flight instruments (Attitude indicator, Airspeed indicator, Altimeter) to assess the situation.

If the aircraft is in a nose-low unusual attitude:

2. Reduce power to idle.
3. Roll the wings to level with aileron input.
4. Pitch the aircraft to level with elevator input.
5. When aircraft is flying straight and level, return to cruise power. Carefully monitor primary flight instruments.

If the aircraft is in a nose-high unusual attitude:

2. Immediately add power to full and pitch the aircraft's nose to level with aileron input.
3. Roll the wings to level with aileron input.
4. When aircraft is flying straight and level, return to cruise power. Carefully monitor primary flight instruments.

NOTE: Remember the phrase "slow is smooth, and smooth is fast". Do not rush unusual attitude recoveries, or you may make incorrect inputs that worsen the situation.

#### **Standards**

Recognize unusual flight attitude.

Perform correct, coordinated and smooth flight control application to resolve unusual attitude.

## Instrument Approach

**Ref:** IPH Ch 4

**Objective:** To safely conduct an instrument approach to a landing.

Upon crossing the **Initial Approach Fix** or intercepting a vector to the final approach course:

1. Start a timer if the approach or procedure calls for it.
2. Begin a turn at standard rate to the applicable course, heading, or track.
3. Set the throttle for 110 MPH.
4. Ensure that the appropriate course or track is tuned, and that the correct navigation source is selected and displayed.
5. Communicate as required with radios.
6. Confirm that the Approach checklist has been completed.

Upon crossing the **Final Approach Fix** or starting final descent to land.,.

1. Start a timer.
2. Extend the landing gear.
3. Set the throttle for descent at 110 MPH.
4. Extend the flaps to 10 degrees.
5. On a non-precision approach, trim for a descent rate of 500 feet per minute or greater. Do not exceed 1000 feet per minute of descent under any circumstances while in instrument flight conditions on final approach.
6. Communicate as required with radios.

NOTE: In all phases of instrument flight, remember to *Aviate, then Navigate, then Communicate.*

NOTE: See Lake Elmo Aero Instrument Syllabus for more specific IFH/IPH references.

### Standards

Maintain altitude +/-100 feet.

\*Beyond FAF, maintain all published altitudes and MDA +100/-0 feet.

Maintain airspeed +/-10 MPH.

Maintain heading +/-10 degrees.

Maintain course +/- ¼ scale deflection.

# Holding

**Ref:** IPH 3-21

**Objective:** To safely execute published or requested holding procedures in instrument conditions.

Upon crossing the holding fix for entry...

1. Start a timer.
2. Turn to the applicable heading, course or track for your chosen hold entry.
3. Set the throttle for 110 MPH.
4. Ensure that the appropriate course or track is selected, and that the correct navigation source is selected and displayed.
5. Communicate as required with radios.
6. Repeat steps 1-5 each time the holding fix is crossed for a new lap.

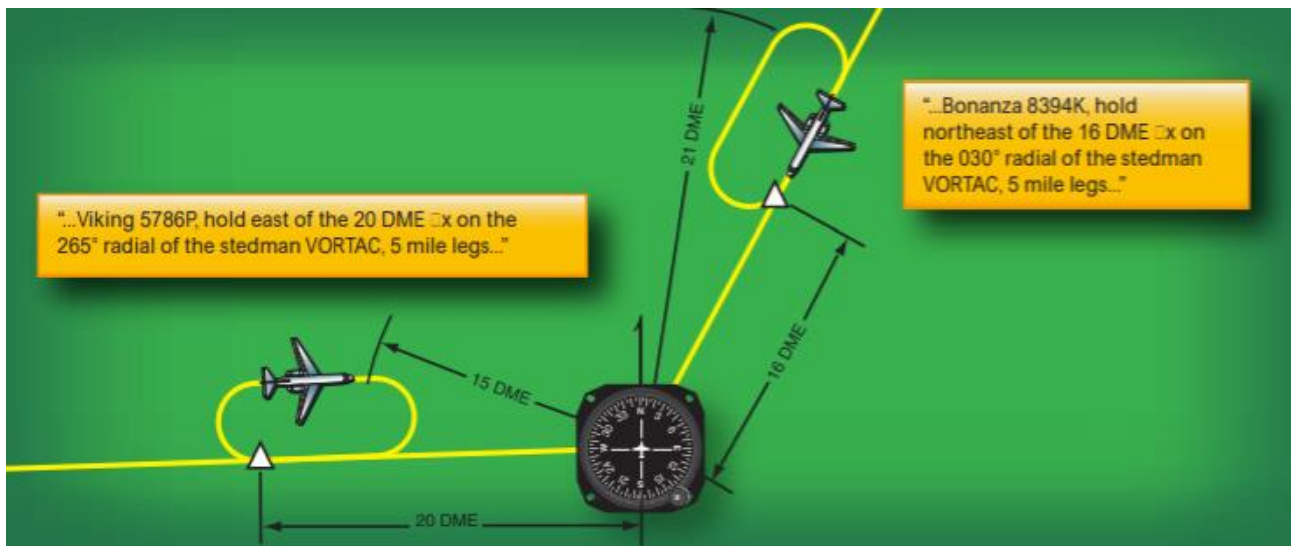

## Standards

- Maintain airspeed +/-10 MPH.
- Maintain altitude +/-100 feet.
- Maintain heading +/-10 degrees.
- Maintain course +/- 3/4 scale deflection.

# EMERGENCIES

## Engine Failure in Flight

**Ref:** AFH 12-22, POH 3-11

**Objective:** To safely configure the aircraft in the event of a complete loss of engine power.

1. Maintain directional control at all times. Be aware that any engine control inputs may cause a “lurch” in directional control and should be corrected promptly and smoothly.
2. Establish flight at 105 MPH [VySE] or greater. Maintain altitude if possible.
3. Set both mixtures to full rich. Disable turbocharger waste gates, if in use.
4. Set both propellers to full forward.
5. Set both throttles to full power.
6. Retract the landing gear, if extended.
7. Retract the flaps, if extended.
8. Ensure both engine fuel selectors are in the “ON” position.
9. Turn both engine auxiliary fuel pumps on.
10. Identify the engine that is malfunctioning. This can be accomplished by checking which foot is no longer applying rudder pressure to maintain directional control of the airplane (hence the adage “dead foot, dead engine”).
11. Verify the affected engine by gradually pulling its throttle to idle. No change in performance should occur.
12. Feather the affected engine by gradually pulling its propeller control to feather.
13. Go to the Engine Shutdown and Feathering Checklist.

<b>ENGINE FAILURE IN FLIGHT</b>	
<b>Directional Control</b>	<b>MAINTAIN</b>
<b>Airspeed</b>	<b>105 MPH</b>
<b>Mixtures</b>	<b>RICH</b>
<b>Propellers</b>	<b>FORWARD</b>
<b>Throttles</b>	<b>FULL</b>
<b>Landing Gear</b>	<b>UP</b>
<b>Flaps</b>	<b>UP</b>
<b>Fuel Selectors</b>	<b>ON</b>
<b>Fuel Pumps</b>	<b>ON</b>
<b><u>Inop</u> Engine</b>	<b>IDENTIFY</b>
<b><u>Inop</u> Engine Throttle</b>	<b>VERIFY</b>
<b><u>Inop</u> Engine Propeller</b>	<b>FEATHER</b>
<i>Go to Engine Shutdown/Feather Checklist.</i>	

## Engine Shutdown and Feathering

**Ref:** AFH 12-22, POH 3-11

**Objective:** To safely secure a failed engine in flight.

1. Trim as required to alleviate control pressure while operating on a single engine.
2. Maintain zero side slip flight attitude (2-3 degrees of bank towards operating engine, coordination ball halfway out towards operating engine).
3. Turn off the auxiliary fuel pump to the inoperative engine.
4. Set the mixture of the inoperative engine to idle cutoff.
5. Turn off the magnetos on the inoperative engine, one at a time. There should be no change in performance.
6. Close the cowl flaps on the inoperative engine.
7. Turn off the alternator on the inoperative engine.
8. Reduce electrical load to prevent overloading remaining alternator or depleting battery.
9. Set the fuel selector on the inoperative engine to "OFF".

NOTE: Crossfeed operations should be considered if required to balance fuel.

<b>ENGINE SHUTDOWN/FEATHER</b>	
Directional Control	MAINTAIN
<i>Maintain zero-side-slip flight attitude.</i>	
Trim	AS REQD
<u>Inop</u> Engine Fuel Pump	OFF
<u>Inop</u> Engine Mixture	CUTOFF
<u>Inop</u> Engine Magnetos	OFF
<u>Inop</u> Engine Cowl Flaps	CLOSE
<u>Inop</u> Engine Alternator	OFF
Electrical Load	REDUCE
<u>Inop</u> Engine Fuel Selector	OFF

## Engine-Out Instrument Approach

**Objective:** To safely conduct an instrument approach with one engine inoperative.

Upon crossing the **Initial Approach Fix** or intercepting a vector to the final approach course:

1. Start a timer if the approach or procedure calls for it.
2. Begin a turn at standard rate to the applicable course, heading, or track.
3. Set the throttle for 110 MPH.
4. Ensure that the appropriate course or track is tuned, and that the correct navigation source is selected and displayed.
5. Communicate as required with radios.
6. Confirm that the Approach checklist has been completed.

Upon crossing the **Final Approach Fix** for a **Precision Approach**:

1. Start a timer if the approach or procedure calls for it.
2. Extend the landing gear.
3. Set the throttle for descent at 110 MPH.
4. Communicate as required with radios.

*Do not extend flaps until runway is in sight and landing is assured.*

Upon crossing the **Final Approach Fix** for a **Non-Precision Approach**:

1. Start a time if the approach or procedure calls for it.
2. Set the throttle for descent at 110 MPH. In the absence of vertical guidance, descent rate should never exceed 1000 feet per minute.
3. Communicate as required with radios.

*Do not extend landing gear or flaps until runway is in sight and landing is assured.*

**NOTE:** Accomplishing a single-engine go-around from an instrument approach is extremely dangerous and should be avoided at all costs. If approach is unstable, consider abandoning early and requesting vectors to re-establish to provide better terrain clearance.

# Fuel Crossfeeding

**Ref:** POH 3-12

**Objective:** To balance fuel if required during flight with one engine inoperative.

1. Ensure the auxiliary fuel pump to the inoperative engine is off.
2. Ensure the auxiliary fuel pump to the operating engine is on.
3. Quickly and forcefully move the fuel selector from the "ON" to the "CROSSFEED" position on the operating engine.
4. Monitor fuel flow and pressure.
5. The auxiliary fuel pump on the operating engine may be turned off if the PIC determines that it is not required for the safety of flight.

To return to normal operation...

6. Turn on the auxiliary fuel pump to the operating engine.
7. Quickly and forcefully move the fuel selector from the "CROSSFEED" to the "ON" position on the operating engine.
8. Monitor fuel flow and pressure.
9. The auxiliary fuel pump on the operating engine may be turned off if the PIC determines that it is not required for the safety of flight.

NOTE: For training flights, the auxiliary fuel pump on the operating engine should be left on whenever an engine is shut down in flight.

<b>FUEL CROSSFEED</b>	
Inop Engine Fuel Pump	OFF
Good Engine Fuel Pump	ON
Good Engine Fuel Select	XFEED
Fuel Flow, Pressure	MONITOR
-----	
Good Engine Fuel Pump	ON
Good Engine Fuel Select	ON
Fuel Flow, Pressure	MONITOR
Good Engine Fuel Pump	AS REQD



## Engine In-Flight Restart

**Ref:** POH 3-12

**Objective:** To restart a previously failed engine and return to normal cruise flight.

1. Turn the fuel selector on the inoperative engine to the “ON” position.
2. Ensure the electric fuel pump on the inoperative engine is turned off.
3. Set the throttle on the inoperative engine to its normal starting position (about ½ inch).
4. Set the propeller control on the inoperative engine to full forward.
5. Set the mixture control on the inoperative engine to full rich.
6. Turn on both magnetos on the inoperative engine.
7. Engage the inoperative engine’s starter to begin windmilling the propeller. The engine should start after several seconds of cranking/windmilling.

*If engine starts...*

8. Set the restarted engine’s throttle and propeller controls to 15” MAP and 2000 RPM for 2 minutes to warm the engine back up to operating temperature (or until the affected engine’s CHT indicates at least 250 degrees). Do not increase throttle above 15” MAP.

*If engine does not start...*

9. Turn the inoperative engine’s auxiliary fuel pump on for 3-5 seconds to prime the engine, then return to step 7.
10. After 6 starter duty cycles of 10 seconds on, 10 seconds off, allow starter to cool for 3 minutes.

<b>ENGINE IN-FLIGHT RESTART</b>	
<i>Perform the following actions on the affected engine’s controls only.</i>	
Fuel Selector	ON
Fuel Pump	OFF
Throttle	½” OPEN
Propeller	FORWARD
Mixture	RICH
Magnetos	ON
Starter	ENGAGE
<i>If engine starts, proceed to Engine Warm-Up Checklist.</i>	
<i>If engine does not start...</i>	
Fuel Pump	ON
<i>Wait 3-5 seconds</i>	
Fuel Pump	OFF
Starter	ENGAGE
<i>If engine starts, proceed to Engine Warm-Up Checklist.</i>	

<b>ENGINE WARM-UP</b>	
<i>Use this procedure after starting an engine in flight.</i>	
Throttle	15” MAP
Propeller	2000 RPM
Cowl Flaps	SET
Engine Instruments	MONITOR
<i>Wait 2 minutes before adding additional power on the engine.</i>	

## Engine Warm-Up

**Objective:** To safely return a recently restarted engine to normal operating temperature.

1. Set the restarted engine's throttle to 15" MAP.
2. Set the restarted engine's propeller to 2000 RPM. This may require some throttle adjustment to maintain 15" MAP.
3. Set the restarted engine's cowl flap as desired. This will typically be closed, so that the engine can more easily return to operating temperature.
4. Monitor the restarted engine's Cylinder Head Temperature on cylinder #1 via the JPI engine monitor. Wait until the temperature reaches at least 200 F before returning to cruise power. In the event that no engine monitoring is available, wait at least two minutes in the throttle/propeller configuration described above.

## Engine Failure on Takeoff

**Ref:** AFH 12-19, POH 3-12a and 3-13

**Objective:** To safely control the airplane in the event of an engine failure on or shortly after takeoff.

*If on the ground...*

1. Immediately close throttles.
2. Apply maximum braking to stop airplane on runway.

*If in the air with usable runway remaining and landing gear is still extended...*

1. Immediately close throttles.
2. Land on remaining runway surface.
3. Apply maximum braking to stop airplane on runway.

*If in the air with no usable runway remaining and landing gear is still extended...*

1. If time and altitude permit, retract landing gear and proceed to Engine Failure in Flight checklist.
2. If time and altitude are insufficient for landing gear extension, immediately find the most suitable landing area and attempt to touch down with minimal groundspeed.

*If in the air with no usable runway remaining and landing gear retracted...*

1. Establish climb at 105 MPH [ $V_{YSE}$ ].
2. Proceed to Engine Failure in Flight.

<b>ENGINE FAILURE ON TAKEOFF</b>	
<b>Throttles</b>	<b>IDLE</b>
<b>Brakes</b>	<b>APPLY</b>
<i>Stop or land safely on remaining runway. Immediately declare RTO to ATC.</i>	

## Engine Fire in Flight

**Ref:** AFH 17-8, POH 3-16

**Objective:** To safely extinguish an engine fire in cruise flight.

1. Set the affected engine’s fuel selector to “OFF”.
2. Close the affected engine’s throttle to idle.
3. Set the affected engine’s mixture to idle cutoff.
4. Set the affected engine’s propeller to feather.
5. Turn the cabin heater and defroster off.

If fire extinguishes...

6. Land as soon as practical.

If fire does not extinguish...

7. Proceed to Emergency Descent procedure if necessary.
8. Land as soon as possible.

<b>ENGINE FIRE IN FLIGHT</b>	
<i>Perform the following actions on the affected engine’s controls only.</i>	
<b>Fuel Selector</b>	<b>OFF</b>
<b>Throttle</b>	<b>IDLE</b>
<b>Mixture</b>	<b>CUTOFF</b>
<b>Propeller</b>	<b>FEATHER</b>
<i>If fire <u>extinguishes</u>, land as soon as practical.</i>	
<i>If fire does not extinguish, proceed to Emergency Descent Checklist (except Mixtures) and land as soon as possible.</i>	

## Engine Fire on Start

**Ref:** POH 3-16

**Objective:** To safely extinguish an engine fire during the starting process.

1. Continue cranking starter to attempt to suck flames and accumulated fuel back into the engine.
2. Set affected engine mixture to idle cutoff.
3. Set affected engine throttle to full open.
4. Turn affected engine auxiliary fuel pump off.
5. Turn Fuel Selector off.

When fire is extinguished and engine is no longer running...

6. Discontinue cranking starter (if applicable) and turn off master switches and magnetos.
7. Evacuate aircraft as soon as practical.

<b>ENGINE FIRE ON START</b>	
<b>Affected Engine Starter</b>	<b>CRANK</b>
<b>Mixtures</b>	<b>CUTOFF</b>
<b>Throttles</b>	<b>FULL</b>
<b>Fuel Pumps</b>	<b>OFF</b>
<b>Fuel Selectors</b>	<b>OFF</b>
<i>When fire is extinguished...</i>	
<b>Master Switches</b>	<b>OFF</b>
<i>Evacuate Aircraft immediately.</i>	

## Electrical Fire

**Ref:** AFH 17-8

**Objective:** To safely extinguish an electrical fire in cruise flight.

1. Turn the master switches Off.
2. Turn all individual radio and electrical switches Off.
3. Close cabin heat and defrost vents on panel to minimize smoke intake from engine compartment. Lower vents can be opened for fresh air if needed.
4. If available, use a fire extinguisher on the afflicted area.
5. Proceed to Electrical Fire Checklist.

If fire does not extinguish...

6. Land as soon as possible. Consider off-airport landing if necessary for safety of occupants.

If fire extinguishes...

7. Land as soon as practical.
8. If electrical power is necessary for continuance of flight, turn master switch on.
9. Check circuit breakers for signs of a faulty circuit. Do not reset any breakers that have been tripped.
10. Turn on individual electrical components one at a time, and ensure that a fire does not restart.
11. Open cabin air and cabin heat/defrost vents as applicable.

<b>ELECTRICAL FIRE</b>	
<b>Master Switches</b>	<b>OFF</b>
<b>All Electrical Switches</b>	<b>OFF</b>
<b>Heater/Defroster Vents</b>	<b>CLOSE</b>
<i>If fire <u>extinguishes</u>, land as soon as possible. If electrical power is necessary for safety of flight...</i>	
<b>Master Switches</b>	<b>ON</b>
<b>Circuit Breakers</b>	<b>CHECK</b>
<i>Turn on individual electrical components one at a time. If fire does not extinguish, land as soon as possible. Consider off-airport landing if necessary.</i>	

## Emergency Descent

**Ref:** AFH 17-6

**Objective:** To safely and rapidly descend the aircraft.

1. Reduce the throttles to Idle.
2. Set the propellers to full forward.
3. Increase the mixtures to rich, unless an engine is on fire.
4. Extend the landing gear.
5. Enter a steep bank (30-45 degrees).
6. Lower the nose of the aircraft and pitch for 150 MPH [VLE].
7. Plan to recover by 1000' AGL.

To recover...

8. Level the wings to the horizon and stop the descent.
9. Apply throttle when airspeed decreases safely below 146 MPH [VA].
10. Return to cruise flight or complete the Power-Off Landing procedure, as applicable.

NOTE: In a non-training scenario requiring this action, descent at up to 217 MPH [VNE] is permitted if necessary, while leaving the landing gear retracted.

<b>EMERGENCY DESCENT</b>	
<b>Throttles</b>	<b>IDLE</b>
<b>Propellers</b>	<b>FORWARD</b>
<b>Mixtures</b>	<b>RICH*</b>
<b>Landing Gear</b>	<b>DOWN</b>
<b>Bank</b>	<b>30-45 DEG</b>
<b>Airspeed</b>	<b>150 MPH</b>

## Engine Roughness

**Ref:** AFH 17-14

**Objective:** To diagnose and rectify a rough-running engine.

1. Open the turbonormalizer wastegates, if they are closed.
2. Turn the auxiliary fuel pumps on.
3. Ensure that both fuel selectors are in the ON position.
4. Set the mixtures to full rich. If already full rich, attempt to slowly lean the mixture by about an inch and a half. This will cause the engine's combustion temperature to increase, which could burn away lead or carbon deposits causing roughness. If no change is observed after one minute, return the mixture to full rich.
5. Switch one magneto off at a time to test for operation of each unit. Never turn off more than one magneto switch at a time.
6. If Engine Roughness continues, land as soon as possible and prepare for a loss of engine power.



## Emergency Landing Gear Extension

**Ref:** POH 3-14

**Objective:** To extend the landing gear in the event of a loss of hydraulic pressure.

1. Check the circuit breaker panel for faults.
2. Ensure the aircraft's master switch is on.
3. Check the output of the alternators.
4. Ensure the aircraft's navigation lights are turned off, to avoid false indications of retracted landing gear due to the automatic dimming feature. [check on this for new panel]
5. Slow the aircraft to 100 MPH or less.
6. Set the landing gear lever to the down position.
7. Pull the emergency gear extension knob.
8. Check landing gear indicator lights for position.

*If gear does not indicate fully extended and locked...*

9. Use abrupt rudder or stabilator control inputs to lock landing gear into place.
10. Have a ground observer confirm the position of the landing gear (preferably a control tower).
11. If landing gear appears down and locked to observers, land normally.
12. If landing gear does not appear down and locked, land at an airport with crash and rescue facilities available and touch down with flaps retracted at the slowest possible speed.

<b>EMERGENCY GEAR EXTENSION</b>	
Circuit Breakers	CHECK
Master Switches	ON
Voltmeter, Ammeters	CHECK
Nav Lights	OFF
Airspeed	<100 MPH
Landing Gear Lever	DOWN
Emergency Gear Extension	PULL
Landing Gear Lights	CHECK
<i>If landing gear is not down and locked, use abrupt rudder or stabilator inputs to move landing gear into place.</i>	

## Loss of Oil Pressure

**Ref:** AFH 17-14

**Objective:** To safely manage a loss of oil pressure in flight.

If Low Oil Pressure is accompanied by **Normal or Low Oil Temperature...**

1. Land as soon as practical.

If Oil Pressure is completely lost, or if Low Oil Pressure is accompanied by **High Oil Temperature...**

1. Prepare for a loss of engine power or engine failure.
2. If the airplane is climbing, stop the climb.
3. Reduce throttles to 18" MAP and maintain level flight.
4. Set mixtures to full rich.

If Oil Pressure and Oil Temperature do not return to normal range...

5. Land as soon as possible.

## High Oil Temperature

**Ref:** AFH 17-14

**Objective:** To safely cool the engine in the event of an overheat.

If High Oil Temperature is accompanied by **Low Oil Pressure...**

1. See “Loss of Oil Pressure” procedure.

If High Oil Temperature is detected, and **Oil Pressure is normal...**

1. If the airplane is climbing, stop the climb.
2. Reduce throttle to 18” MAP for a minute or so while allowing the airplane to accelerate. This will force more air over the engine. If airplane is equipped with CHT gauge, monitor this as well (keep below 420F/215C if possible).

If Oil Temperature returns to normal...

3. Resume normal operations, but climb at a higher speed (at least 105 MPH [Vy] to facilitate cooling) when required.

If Oil Temperature does not return to normal...

4. Land as soon as practical.

## Alternator Failure

**Ref:** POH 3-15, AFH 17-11

**Objective:** To manage electrical load and return for a safe landing in the event of an alternator failure.

1. Cycle the affected alternator’s master switch.
2. Prepare for the possibility of an electrical fire. Go to the Electrical Fire procedure if applicable.
3. Turn off all unnecessary electrical equipment to reduce system load, including...
  - a. External lights (as safe/required).
  - b. Secondary communication radio(s).
4. Unplug all devices from the airplane’s 12-volt charging socket.
5. Check circuit breakers.
  - a. If no circuit breakers are tripped, cycle the Alternator Master Switch.
    - i. If Alternator power is not restored, land as soon as possible.
  - b. If one or more circuit breaker(s) is tripped...
    - i. If the equipment is unnecessary for the safety of flight, leave it tripped and cycle the Alternator Master Switch.
    - ii. If the equipment *is necessary* for the safety of flight, the use of emergency authority to reset the breaker can be used. Land at the nearest suitable airport.
6. Minimize inputs that require heavy electrical load, including transmitting on Communication radios.
7. Land as soon as practical (if in IMC, land as soon as possible).

NOTE: Resets of circuit breakers protecting necessary equipment can be attempted, but prepare for the possibility of an Electrical Fire and do not attempt to reset the same breaker more than once.

NOTE: The Piper Seneca is equipped with a overvolt-sensing alternators, which will shut off if output voltage exceeds 14 volts. This will trigger a red annunciator light and will take the form of an Alternator failure.

<b>ALTERNATOR FAILURE</b>	
<u>Inop</u> Alternator Switch	CYCLE
<i>If power is not restored...</i>	
Electrical Load	REDUCE
<i>Turn off all electrical components not necessary for the safety of flight.</i>	
12V Charging Port	UNPLUG
Circuit Breakers	CHECK
<i>If no circuit breakers tripped...</i>	
<u>Inop</u> Alternator Master	CYCLE
<i>If power is not restored, land as soon as practical.</i>	

## Electrical System Failure

**Ref:** AFH 17-11

**Objective:** To manage electrical load and return for a safe landing in the event of a loss of electrical power.

1. Turn off battery and alternator master switches.
2. Turn off all individual electrical switches (such as lights and Avionics Master switch).
3. Prepare for the possibility of an electrical fire. Go to the Electrical Fire procedure if applicable.
4. Turn the battery master switch on.
  - a. If electrical power is not restored, land as soon as practical and do not continue troubleshooting.  
Due to the electrical system being inoperative, plan to land without flaps.

If electrical power is restored...

5. Turn the alternator master switches on.
  - a. If Alternator Over-Voltage Light illuminates, turn alternator master switch Off and land as soon as practical.
6. Individually, turn on each component to isolate the problem. Use caution and make sure each individual component does not cause an electrical abnormality.
7. Land as soon as practical.

## Spin Recovery

**Ref:** AFH 4-13

**Objective:** To safely recover from an uncoordinated, aggravated stall.

1. Reduce the Throttles to Idle.
2. Return the Ailerons to the neutral position. Attempting to recover from a spin with aileron input can further aggravate the spin.
3. Apply Rudder input in the direction opposite to the spin. The aircraft should stop spinning and become oriented in a steep dive.
4. Apply forward pressure on the Elevators to break the stall condition. Do not invert the aircraft or exceed 217 MPH [VNE].

When the stall is broken and the aircraft is controllable...

5. Gradually recover from the dive and return to level flight with elevator input. Do not recover abruptly in order to avoid overstressing the aircraft beyond its rated structural limits (+3.8G) or inducing a secondary stall.
6. When level flight has been achieved, apply throttle as necessary to return to cruise flight.

NOTE: Remember the following mnemonic in the event of a spin: **PARE**.

**Power:** Idle.

**Ailerons:** Neutral.

**Rudder:** Opposite, to break the spin.

**Elevator:** Forward, to break the stall. Then back to recover from the dive.